

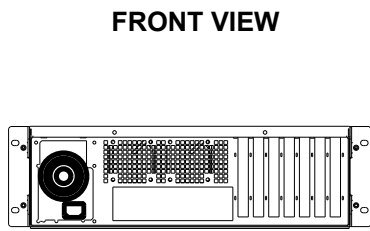

| IMAGE PROCESSORS | MAX BTU | RACK WEIGHT (lb) |
|---------------------|---------|------------------|
| DI-6000 MULTICARD 2 | 819 | 32.25 |
| DI-6000 MULTICARD 3 | 973 | 32.25 |
| DI-6000 MULTICARD 4 | 1126 | 32.25 |

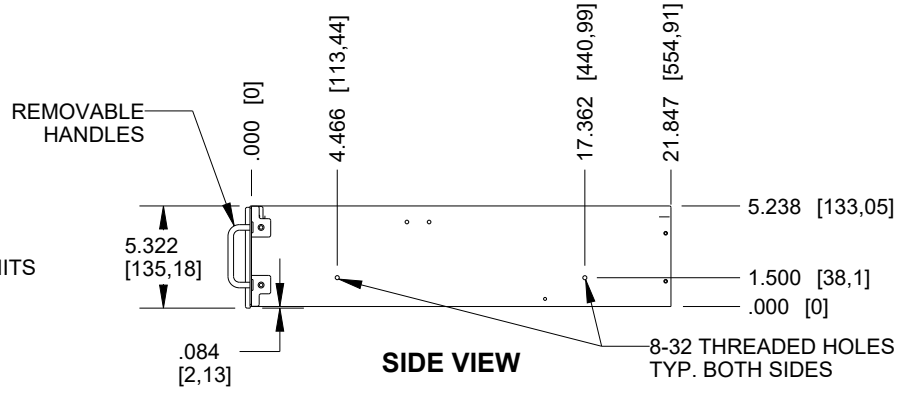
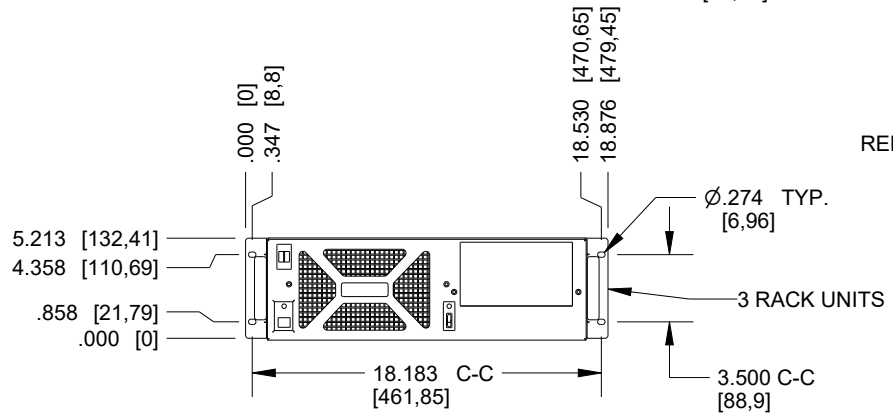
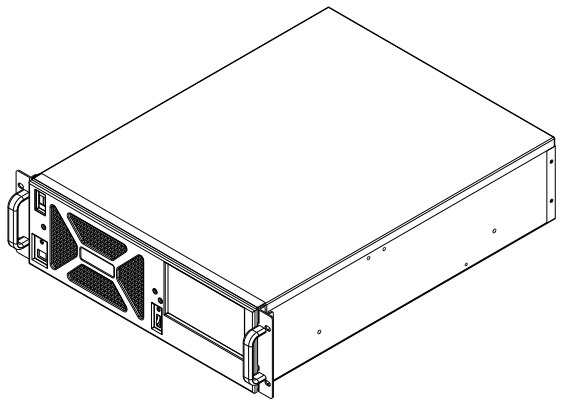
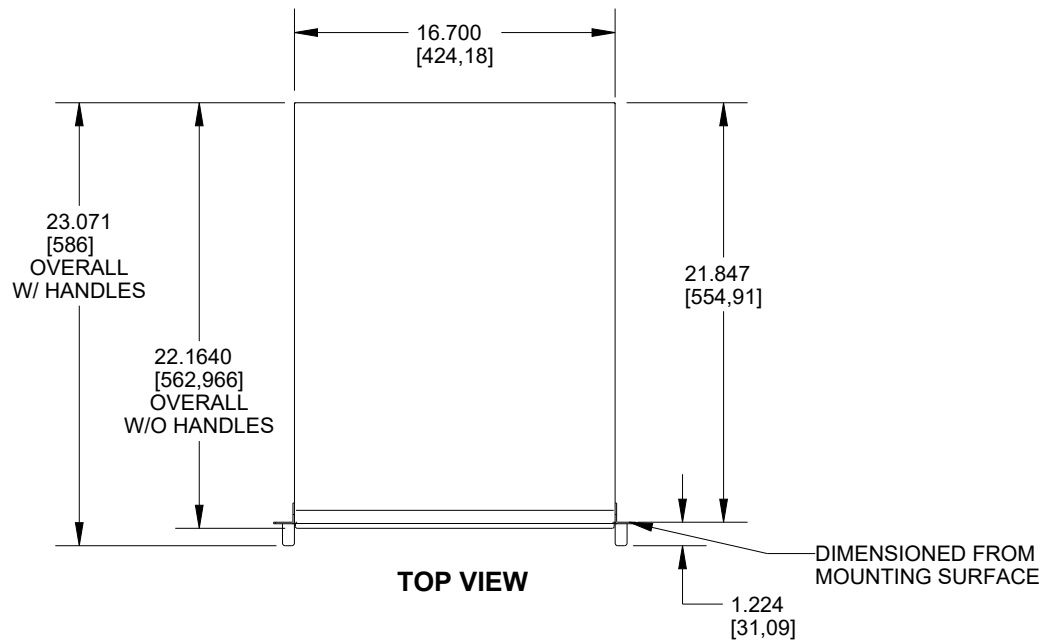
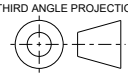

| REV: | DATE: | DESCRIPTION: | BY: |
|--|---------------------------------|--------------------|--|
| | | | |
|  THE CONCEPTS EXPRESSED AND DETAILS SHOWN ON THIS DRAWING ARE CONFIDENTIAL AND PROPRIETARY. DO NOT REPRODUCE BY ANY MEANS WITHOUT THE EXPRESS WRITTEN CONSENT OF DAKTRONICS, INC. OR ITS WHOLLY OWNED SUBSIDIARIES. COPYRIGHT 2022 DAKTRONICS, INC. (USA) | | |  THIRD ANGLE PROJECTION |
| PROJECT: 3RU DI-6000 ENCLOSURE | | | |
| TITLE: 3RU DI-6000 ENCLOSURE DETAILS | | | |
| DATE: 11-JUL-22 | DIM UNITS: INCHES [MILLIMETERS] | SHEET | REV |
| SCALE: 1/10 | DO NOT SCALE DRAWING | | 00 |
| DESIGN: KSCHNABEL | JOB NO. | FUNC - TYPE - SIZE | 5103238 |
| DRAWN: KSCHNABEL | P2121 | F - 07 - A | |